

User Manual

**ANALOG/DIGITAL, POSTIONER RECEIVER WITH
EMBEDDED VIACCESS AND COMMON INTERFACE**

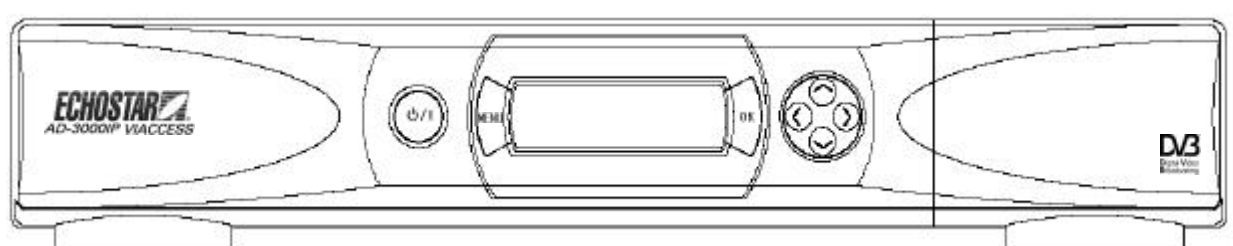

ECHOSTAR
AD-3000IP VIACCESS

CONTENTS

1. Safety instructions	2
2. Features	3
3. Front & rear view	5
4. Remote Control Unit (RCU)	7
5. Getting started	8
6. How to connect your dish to the EchoStar AD-3000IP VIACCESS	11
7. Operation and menu program	13
A. Receiver and TV set-up	13
B. Main menu & Installation	19
C. Advanced Installation	26
8. Specifications	28
Appendix. Tri control database remote	31



Trade Mark of the DVB Digital Video Broadcasting Project (1970)

1. Safety Instructions

WARNING!

Always follow these instructions to avoid the risk of injury to yourself or damage to your equipment.

Unplug the receiver from the AC power outlet before cleaning. Use only a damp cloth for cleaning the exterior of the receiver.

Do not use accessories or attachments not recommended by the receiver manufacturer, as they may cause hazards and will void the warranty.

Do not operate the receiver in high-humidity areas, or expose it to water or moisture.

Do not place the receiver on an unstable cart, stand, tripod, bracket, or table. The receiver may fall, causing serious personal injury and damage to the receiver.

Do not block or cover slots and openings in the receiver. These are provided for ventilation and protection from overheating. Never place the receiver near or over a radiator or heat register. Do not place the receiver in an enclosure such as a cabinet without proper ventilation.

Do not stack the receiver on top of or below other electronic devices.

Operate the receiver using only the type of power source indicated on the marking label. Unplug the receiver power cord by gripping the power plug, not the cord.

Route power supply cords so that they are not likely to be walked on or pinched by items placed upon or against them. Pay particular attention to cords at plugs, convenience receptacles, and the point where they exit from the unit.

Use an outlet that contains surge suppression or ground fault protection. For added protection during a lightning storm, or when the receiver is left unattended and unused for long periods of time, unplug it from the wall outlet and disconnect the lines between the receiver and the antenna. This will provide some protection against damage caused by lightning or power line surges.

Do not attempt to service the receiver yourself, as opening or removing covers may expose you to dangerous voltage, and will void the warranty. Refer all servicing to authorized service personnel.

Unplug the receiver from the wall outlet and refer servicing to authorized service personnel whenever the following occurs:

- The power supply cord or plug is damaged;
- Liquid has been spilled, or objects have fallen into the receiver;
- The receiver has been exposed to rain or water;
- The receiver has been dropped or the chassis has been damaged;
- The receiver exhibits a distinct change in performance.

2. Features

Common Section

1. Satellites : up to 50 satellites, 999 transponders
2. 4-digit 7-segment LED on the front panel displays channel information
3. Displays local time on the front panel in stand-by mode
4. Proprietary EchoStar OSG menu
5. 64-step volume control
6. VCR timer function (position, Digital/Analog, channel, start time, stop time)
7. Power recovery function
8. Last channel memory function
9. Favorite channel function (mixed Digital & Analog)
10. C/Ku control function
11. Parental lock / Installation & Edit lock / Receiver lock
12. Variety of LNB polarity control; 13/18V, 0/22kHz tone, 0/12V,
Mechanical polarizer, magnetic polarizer (Ferrite) and DiSEqC 1.0™
13. RS232C port for additional information service and update of the receiver control software
14. DiSEqC 1.0™ compatible
15. Mechanical and magnetic polarizer control for each satellite
16. Auto Sat position search
17. Channel storing for multi satellites
18. Built-in positioner (high power azimuth control (36Vdc, 5A))

Digital Section

1. MPEG-2 Video (MP@ML)
2. MPEG-1 Audio layer 1, layer 2
3. MPEG-2 Digital & fully DVB compliant
4. Viaccess embedded with 1 smart card
5. Capable of interfacing with the CAMs of DVB Common Interface standard
6. Capable of scanning the frequency for SMATV system
7. On-screen display with 256-color full resolution
8. Plug & Play installing program set-up
9. LD quality video, CD quality audio
10. RS232C port for additional information service and update of the receiver control software
11. Displays signal level to set up the satellite antenna with ease
12. Powerful editing facilities;
 ; PIDs, TV or Radio channel, channel name, satellite name, transponder name
13. Teletext function (Your TV should support teletext.) & Subtitling
14. SCPC/MCPC receivable from C/Ku-band satellites
15. Variable aspect ratio (4:3, 16:9) with pan vector
16. EPG for on-screen channel information
17. Multi-lingual function when provided by the satellite and broadcasting service provider
18. Total 5000 channels programmable (4000 Channels for TV & 1000 Channels for Radio)
19. S/PDIF(Sony/Philips Digital Interface) for the digital audio

Analog Section

1. 700 programmable channels
2. 1 IF input (900-2150MHz) / 1 bandwidth (27MHz)
3. 32-step low threshold extension (3dB)
4. Audio mono / stereo selectable
5. C/ Ku band (invert/ normal video format) selectable
6. 4 video level control
7. 4 decoder modes
8. Color GUI (Graphic User Interface) menu
(overlaid with digital graphic OSG menu and analog background live picture)
9. Powerful editing facilities; channel name, satellite name

3. Front & Rear View

Front Panel

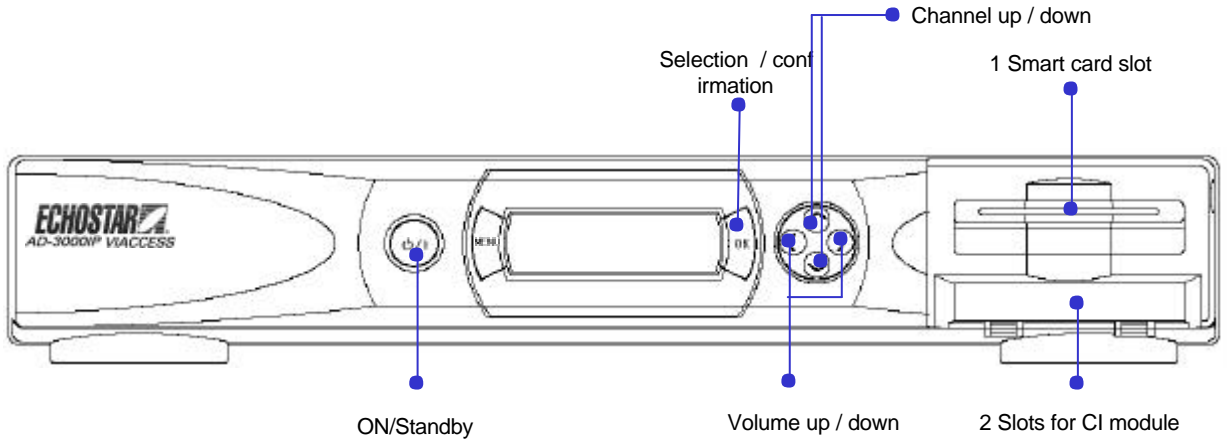

Rear Panel

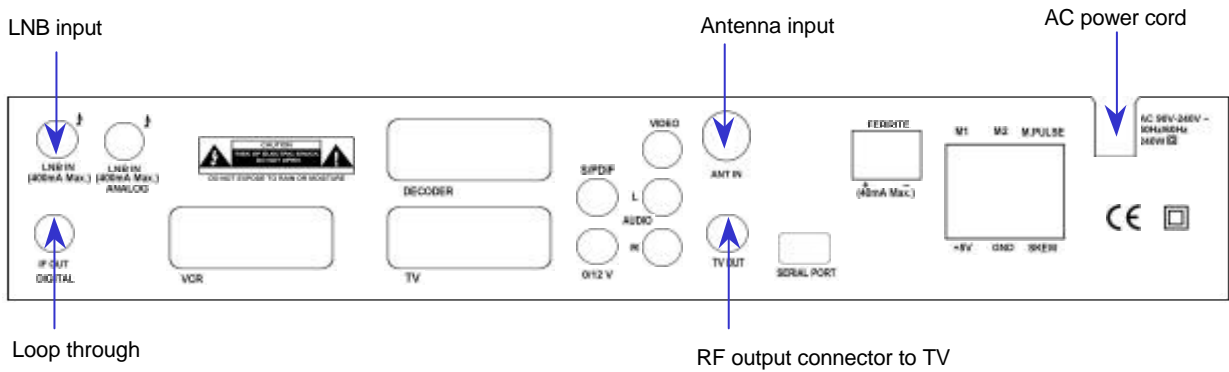

Note: All the cables used for Input/Output connection for the receiver should be well shielded.

Smart Card and CI Module

To watch payable program channels, a CI module and a smart card from the service provider is necessary. (The service provider is the distributor of the programs). CI modules and smart cards are only licensed to service providers only and they are distributed by their dealers or agents.

If you are subscribed to the services of more than one service provider, you might have to insert or change proper smart card and proper CI module of your choice.

Without CI module and smart card, only FTA (free-to-air) programs are available to watch.

Note : 1) **The main plug must not be plugged in before inserting the CI module.**

- 2) Insert the CI module fully into the slot behind the lid in the front panel of the receiver, towards the arrow on the module facing upwards and inwards.
- 3) Insert your smart card fully into the slot on the CI module towards the arrow on the card facing upwards and inwards.
- 4) CI module and smart card may give special menus which are not described in this manual.
- 5) A smart card is connected to a single service provider and to a specific range of channels.

4. Remote Control Unit (RCU)



The **Power** key turns the receiver on and off.



The **LED** (Light Emitting Diode) flashes red to show the remote is working.



The **TV**, **VCR** and **SAT** keys select the device to be controlled. Pressing the **SAT** key allows the remote to control the functions of the receiver.



The **Volume** and **Channel** keys control the two most frequently used functions of the receiver.



The **Mute** key switches the sound on and off.



Number / Input keys enable direct channel selection command selection using numeric keys.

The **TV/RAD(Radio)** key switches between TV and radio mode. The **FAV** key shows a list of your selected favorite channels (To define channels as favorite select the “*Edit TV channel*” menu).

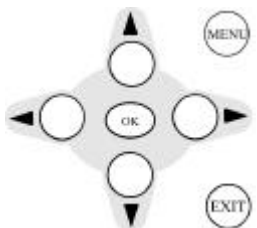

The **MENU** key is used to see main menu or to return to previous menu.

The cursor keys are for channel \uparrow and \downarrow and volume \leftarrow and \rightarrow .

The **OK** key is used to select a program, a highlighted line or parameter value. Also you can see TV/Radio channel list while watching TV or listening to the radio.

The **EXIT** key exits to the video viewing mode at any time.



The **EPG** key shows program information of the selected channel. (**EPG**; Electronic Program Guide)



The **Information** key provides additional information about the current channel and program (only available when provided by the broadcaster). In the menus pressing this key provides up to four lines of help.



The **Subtitle** key enables subtitling (only when provided by the broadcaster).



Selects the **Audio Language or Soundtrack** from among the data transmitted for the current channel.



VIEW

Shows a **thumb nail** representation of the current channel in the “*Edit TV Channel*”, “*Parental Lock*” and “*EPG*”.



SAT

The **SAT** key shows a list of selectable satellites.



5. Getting Started

DO NOT PLUG the receiver into Main Power Outlet, until you complete all the connections to the receiver.

Receiver to TV with RF

1. Connect the Off-air TV antenna or cable if available to the ANT IN socket of the **EchoStar AD-3000IP VIACCESS**.
2. Connect the TV OUT socket of the **EchoStar AD-3000IP VIACCESS** to the RF IN of the TV set.
3. Search on the TV set for UHF channel # 38. This is the default channel where the **EchoStar AD-3000IP VIACCESS** is set to.

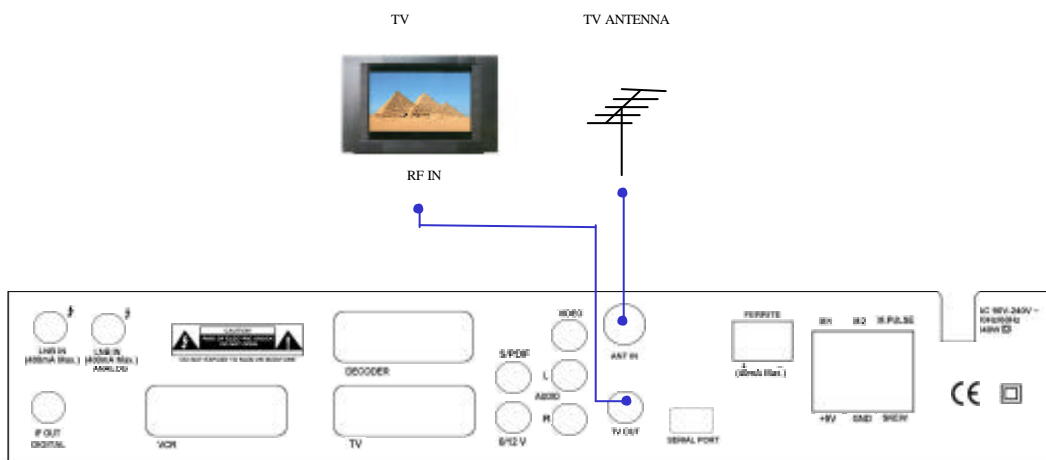

Receiver to VCR and then to TV with RF

1. Connect the Off-air TV antenna or cable if available to the ANT IN socket of the **EchoStar AD-3000IP VIACCESS**.
2. Connect the TV OUT socket of the **EchoStar AD-3000IP VIACCESS** with the RF IN of the VCR.
3. Connect the RF OUT of the VCR to the RF IN of the TV set.
4. Search on the TV set and the VCR for UHF channel # 38. This is the default channel where the **EchoStar AD-3000IP VIACCESS** is programmed to.

Note : Use different UHF channels for VCR and **EchoStar AD-3000IP VIACCESS**.

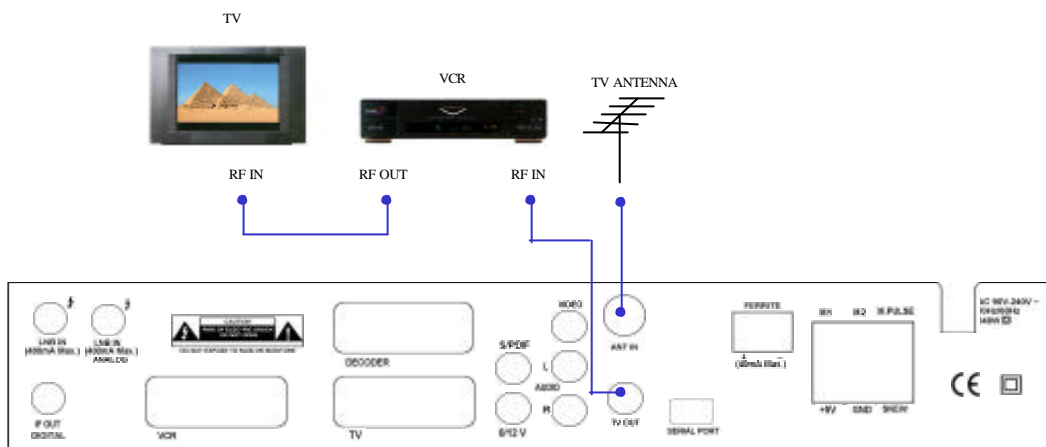

Receiver to TV with Audio and Video RCAs

1. Connect the Off-air TV antenna or cable if available to the ANT IN socket of the **EchoStar AD-3000IP VIACCESS**.
2. Connect the TV OUT socket of the **EchoStar AD-3000IP VIACCESS** with the RF IN of the TV set.
3. Connect the Video and Audio RCAs of the **EchoStar AD-3000IP VIACCESS** to the Video and Audio RCAs of the TV set.

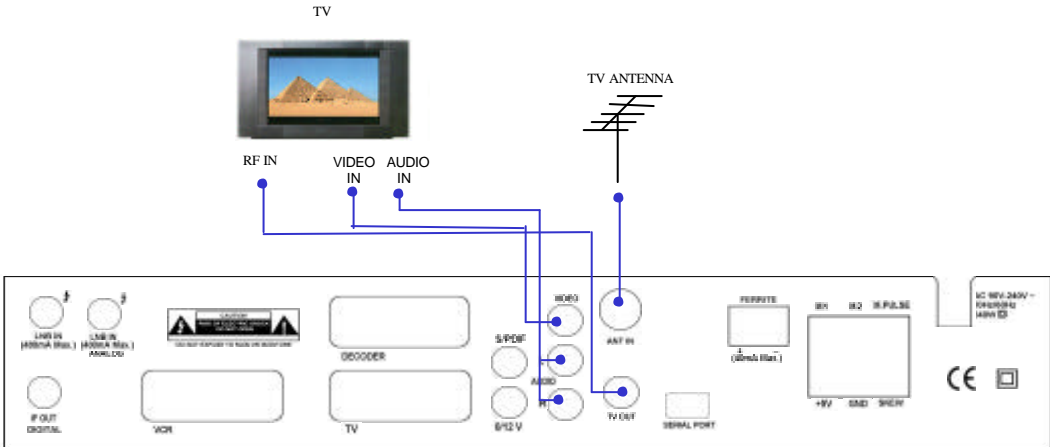

Receiver to TV and VCR with SCART Cables

1. Connect the Off-air TV antenna or cable if available to the ANT IN socket of the **EchoStar AD-3000IP VIACCESS**.
2. Connect the TV OUT socket of the **EchoStar AD-3000IP VIACCESS** with the RF IN of the VCR.
3. Connect the RF OUT of the VCR to the RF IN of the TV set.
4. Search on the VCR for UHF channel # 38. This is the default channel where the **EchoStar AD-3000IP VIACCESS** is programmed to.
5. Connect the SCART cable from the TV SCART of the **EchoStar AD-3000IP VIACCESS** to the SCART of the TV set.
6. Connect the SCART cable from the VCR SCART of the **EchoStar AD-3000IP VIACCESS** to the SCART of the VCR.
7. When the **EchoStar AD-3000IP VIACCESS** is switched on the TV set, TV set will automatically switch to the relevant SCART input of the TV.

Note : Use different UHF channels for VCR and **EchoStar AD-3000IP VIACCESS**.

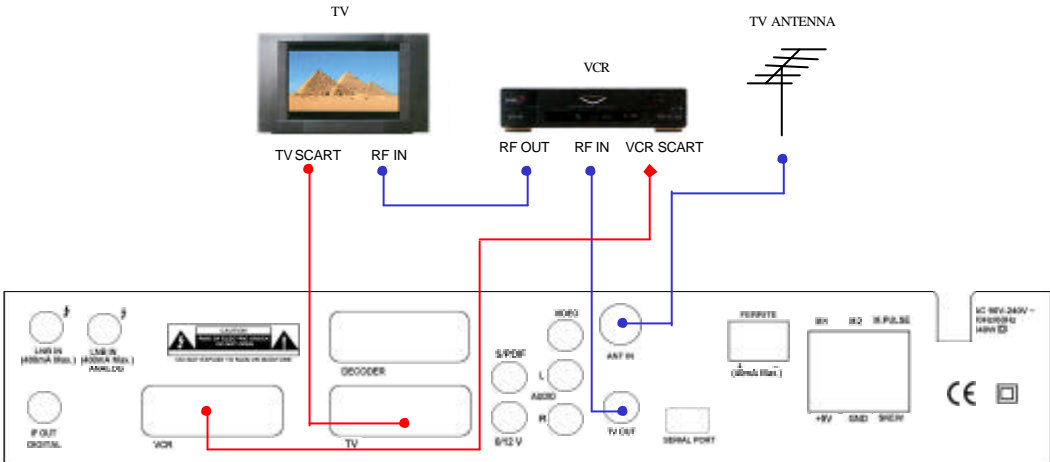

Receiver to TV, VCR and Decoder with SCART Cables

1. Connect the Off-air TV antenna or cable if available to the ANT IN socket of the **EchoStar AD-3000IP VIACCESS**.
2. Connect the TV OUT socket of the **EchoStar AD-3000IP VIACCESS** to the RF IN of the VCR.
3. Connect the RF OUT of the VCR to the RF IN of the TV set.
4. Search on the VCR for UHF channel # 38. This is the default channel where the **EchoStar AD-3000IP VIACCESS** is programmed to.
5. Connect the SCART cable from the TV SCART of the **EchoStar AD-3000IP VIACCESS** to the TV SCART from the TV set.
6. Connect the SCART cable from the VCR SCART of the **EchoStar AD-3000IP VIACCESS** to the SCART of the VCR.
7. Connect the SCART cable from the DECODER SCART of the **EchoStar AD-3000IP VIACCESS** to the SCART of the DECODER.

Note : Use different UHF channels for VCR and **EchoStar AD-3000IP VIACCESS**.

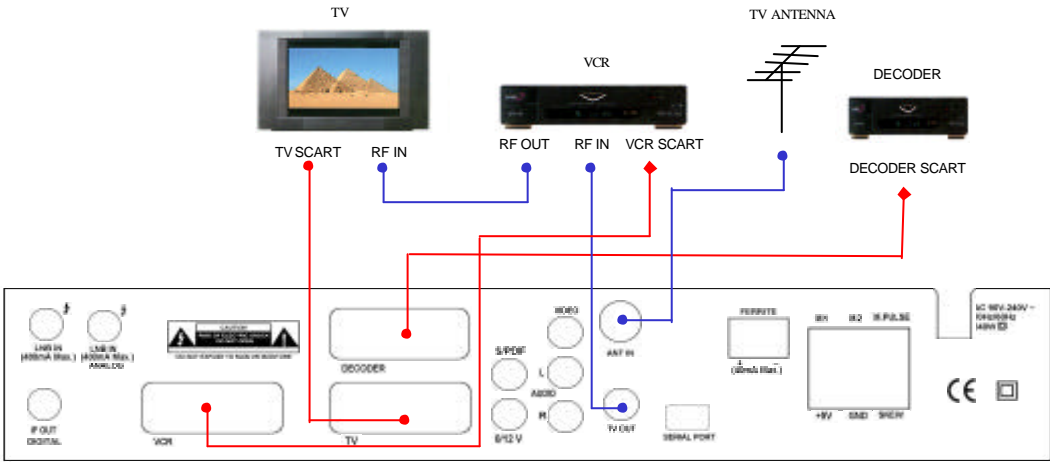

6. How to connect your dish to the EchoStar AD-3000IP VIACCESS

One Actuated Dish

1. Connect the IF OUT and LNB IN connectors using the loop through cable provided with the EchoStar AD-3000IP VIACCESS.
2. Connect the LNB IN socket of the EchoStar AD-3000IP VIACCESS to the LNB.
3. Connect motor wires to M1 and M2. Switch these connections if the motor moves to the wrong direction.
4. Connect sensor wires to M.PULSE and GND connector.
5. Connect a mechanical polarotor to +5V, GND and SKEW connectors. [optional]
6. Connect ferrite polarizer to ferrite connectors. [optional]

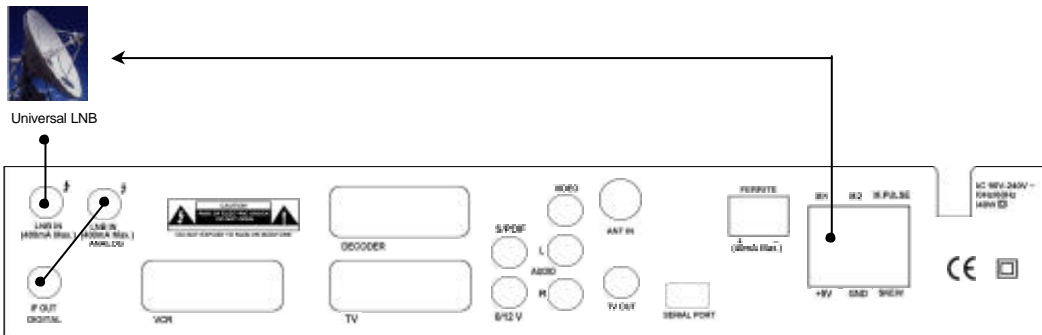

One Actuated Dish with C/Ku feed

1. Connect the IF OUT and LNB IN connectors using the loop through cable provided with the EchoStar AD-3000IP VIACCESS.
2. Connect the cables from C and Ku-band LNB to a 12 Volt C/Ku switch.
3. Connect the coaxial cable from the 0/12 Volt switch to the LNB IN connector.
4. Connect the power cable which comes from the 0/12 Volt switch to the 0/12V(connector).
5. Connect motor wires to M1 and M2. Switch these connections if the motor moves to the wrong direction.
6. Connect sensor wires to M.PULSE and GND connector.
7. Connect polarotor to +5V, GND and SKEW connectors. [optional]

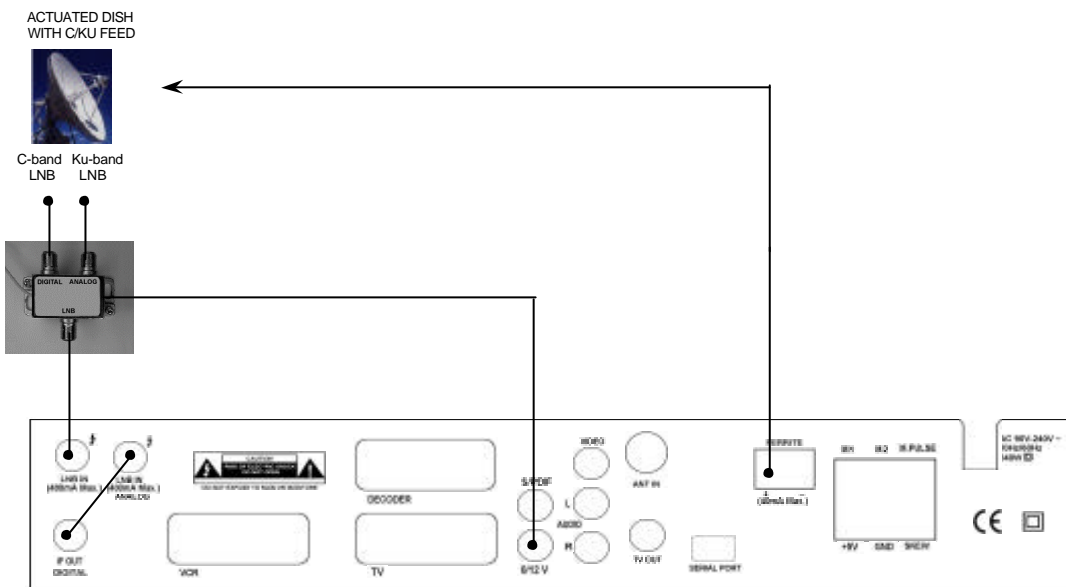

Two Fixed Dishes using DiSEqC mode

1. Connect the IF OUT and LNB IN connectors using the loop through cable provided with the **EchoStar AD-3000IP VIACCESS**.
2. Connect the DiSEqC 1.0 or Toneburst switch to the LNB IN connector of the **EchoStar AD-3000IP VIACCESS**.
3. Connect both dishes to the 2 inputs from the DiSEqC switch.

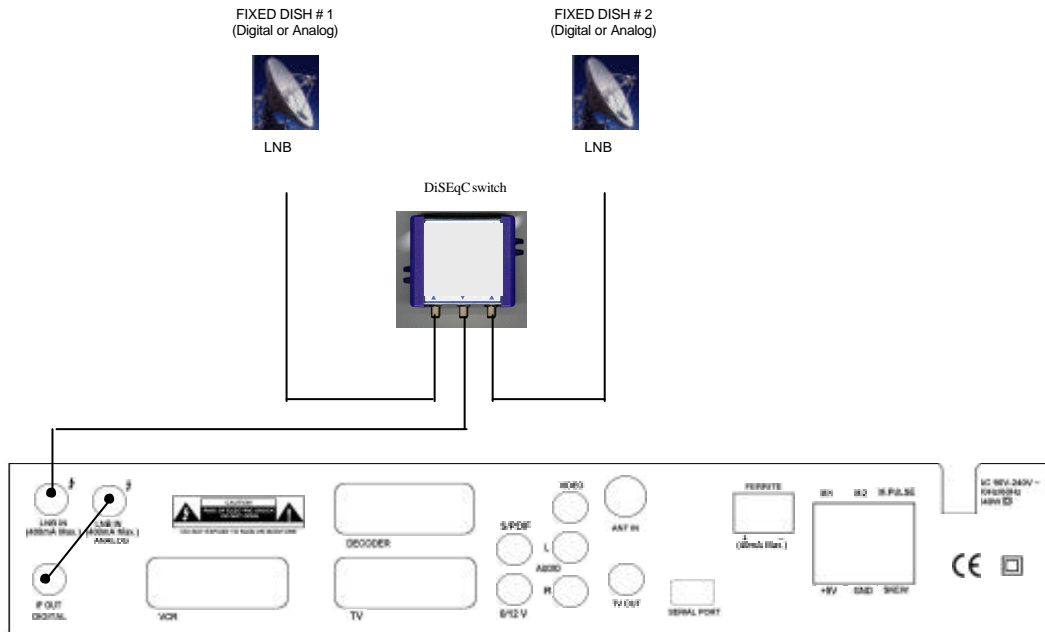

5. Operation and Menu Program

A. Receiver and TV set-up

Check the Installation

To get the most out of the **EchoStar AD-3000IP VIACCESS** it should be correctly installed, the dish should be optimally aligned and the mechanical limit switched on the dish should be set properly.

Press  /I on the remote control unit (RCU) or press  on the front panel of the **EchoStar AD-3000IP VIACCESS** to switch the unit on.

The receiver is supplied with factory setting and will start up with the “*Language Setting*” menu.

After selecting the language settings, the “*LNB Setting*” menu will be shown. Please follow the steps outlined below to properly install the **EchoStar AD-3000IP VIACCESS**.

Language Setting

You can select the desired language for the OSG (On-Screen Graphics) display using the **., .** keys when the “Menu Language” option is selected. Similarly you can select a different audio channel when the “Audio Language” option is selected. This option allows you to select a different language to listen to if supported.

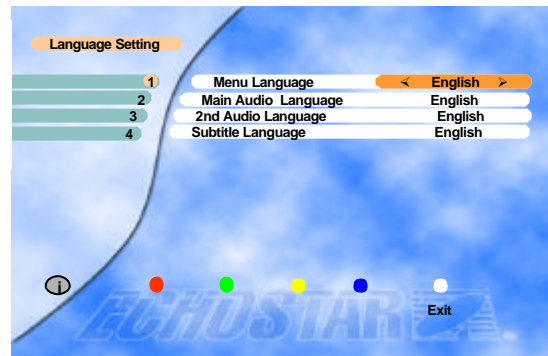

LNB Setting

Select the “LNB Setting” menu in the “Installation” menu using the **., .** keys.

Select the LNB type which conforms to your LNB using the **., .** keys.

Other parameter values should be changed manually according to your LNB type.

Press the **OK** key to confirm your selection.

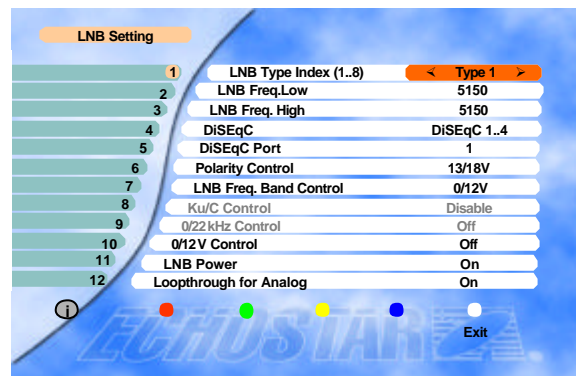

If you have a Mechanical Polarizer with your LNB, you have to set the “Polarity Control” parameter in this menu to [Polarotor].

If the Loophthrough option is set to ON, the Loophthrough ports should be set according to the diagrams on pages 11. If no Loophthrough is used this option should be set to OFF.

Antenna Installation

First the east and west limits have to be set before any satellites can be programmed.

Press the **.** key on the “East Limit” parameter line. The initial value of 5000 will decrease as the dish is moved. Keep moving the dish until the east limit is reached. If the dish is moved to the west when you press the **.** key, reverse the motor wires.

If either the numeric value is not shown or the message “...Motor Error...” is displayed on the lower left part of the screen, then,

- 1) an error occurred when moving the dish (which could be caused by i.e. loose wires), or
- 2) the dish has reached its east limit. In this case continue with the installation procedure.

Move the dish a few counts to the west by pressing the **.** key and press the **OK** key to store east limit in this position. The indicated number will be set at 1000 and the highlight will be moved down to the “West Limit” line. Now set the west limit by moving the dish using the **.** key until you have reached the dish limit. The indicated number will increase from 1000. Move the dish back a couple of counts using the **.** key and press the **OK** key to store the west limit.

The dish limits are now stored in the receiver and the dish is in the most western position. Press the **SAT** key to start the “Auto Sat” function or you can press **MENU** to program the satellites manually.

*If you do not have a moveable dish, just press the **OK** key twice to program the east and west limit in the same position. This will be indicated by a numeric value of 1000 for both limits.*

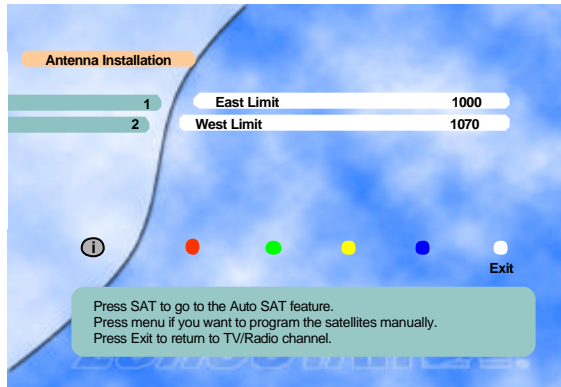
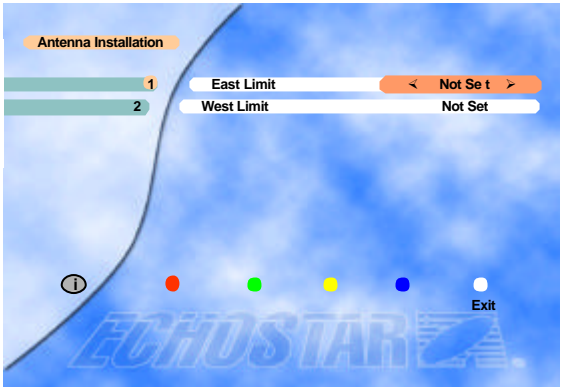

Auto SAT

Now press the **.** or **,** key to select the most western position you can receive.

Press the **OK** key.

Select the Position option and move the dish using the **.** key to correct location of the western satellite. Peak the dish to obtain the highest signal quality using the **,** and **.** keys. Then press the **OK** key to store this setting.

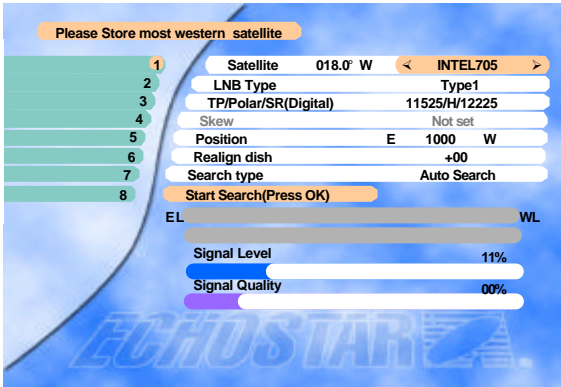

Go back to Satellite option using the **←** key.

Now press the **→** or **↑** key to select the middle satellite.

Press the **OK** key.

Select the position using the **←** key and with the **↑** key move the dish to the correct location of the middle satellite. Peak the dish to obtain the highest signal quality using the **←** and **→** keys.

Then press the **OK** key to store this setting

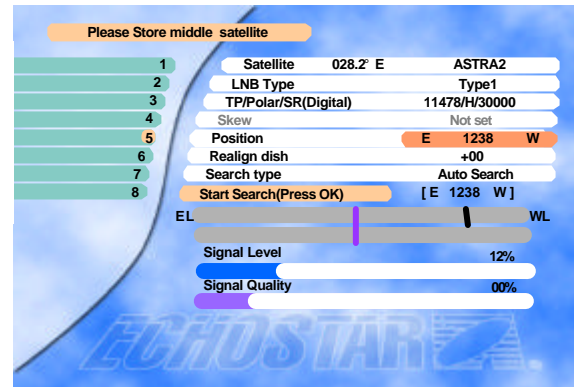

Go back to the Satellite option using the **←** key.

Now press the **→** or **↑** key to select the most eastern satellite you can receive.

Press the **OK** key.

Select the Position option using the **←** key move the dish to the correct location of the eastern satellite. Peak the dish to obtain the highest signal quality using the **←** and **→** keys.

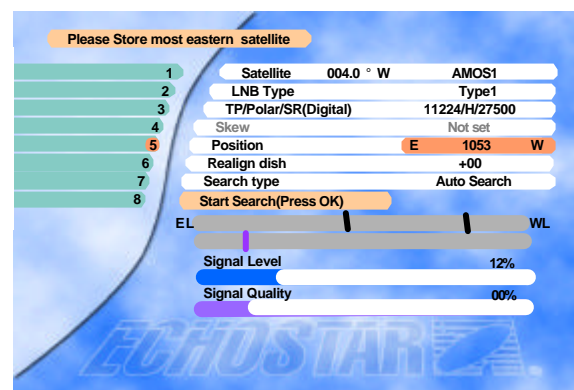

Press the **SAT** key to let the receiver calculate all intermediate satellite positions. All selected satellite positions are now stored for both the digital and analog mode.

Press the **MENU** key twice to return to the installation screen. Select Auto Channel Search (for more information on this option please refer to page 20). The **EchoStar AD-3000IP VIACCESS** will start the search on the most eastern satellite.

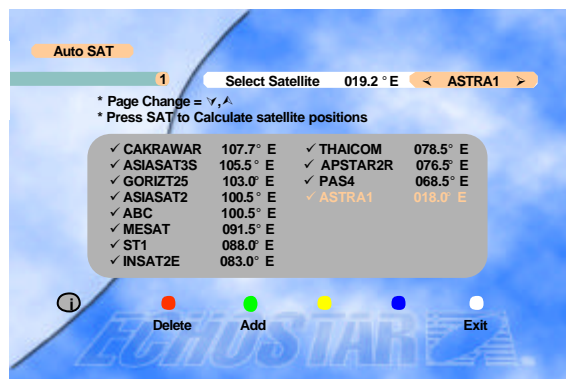
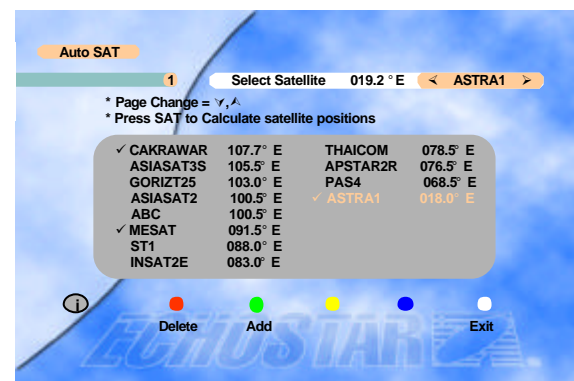

Program Satellites

The **EchoStar AD-3000IP VIACCESS** now has programmed the position of all selected satellites. The next step is to store all channels on these satellites. To do this press the **MENU** key, select the Installation option followed by the Program Satellites option. Use the **←** key to select the next satellite and press the **OK** key. The dish will move to the selected satellite.

Select Start Search to store all channels. Repeat this procedure for all satellites.

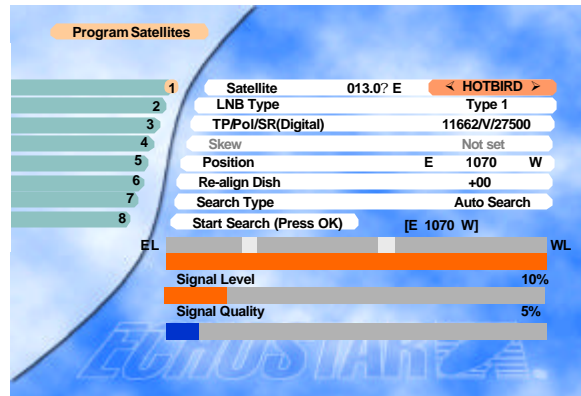

Motorized Dish Setting

If you are not satisfied with the Limit parameters e.g. since the mechanical limits might not be set properly, you can erase the position data and start again after adjusting the mechanical limits at the dish.

Go in to the “*Motorized dish setting*” menu with the **←** key to “*Erase Position Data*” and press the **OK** key. Then go to “*Erase All Satellite Data*” press the **red** key twice. Press the **MENU** key, go to Installation, Motorized Dish Setting, Antenna Installation, press the **OK** key and proceed from start.

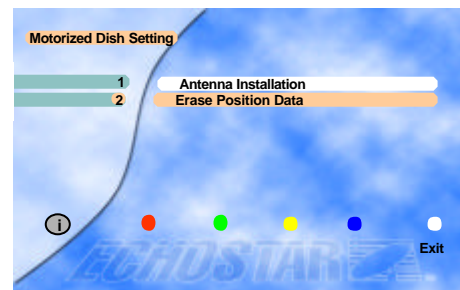
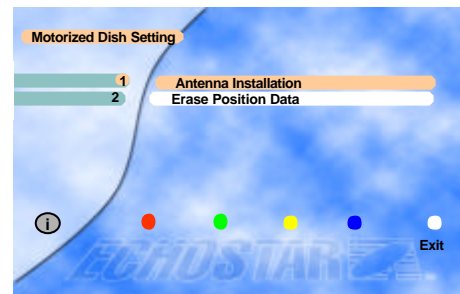

Erase Position Data

Select in the Erase Position Data Menu “*Set Present Sat as fixed*”, using the **←**, **→** keys.

If signals from this satellite are received with a fixed dish, the movable dish will not move to this satellite.

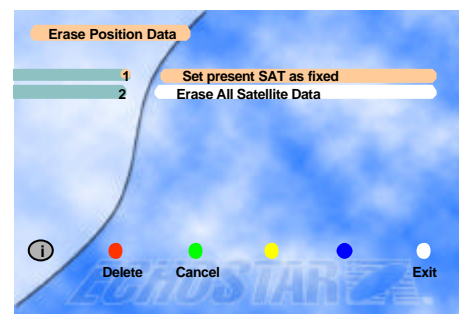

User's Setting

User's Settings are only accessible via the Installation screen.

Language Setting

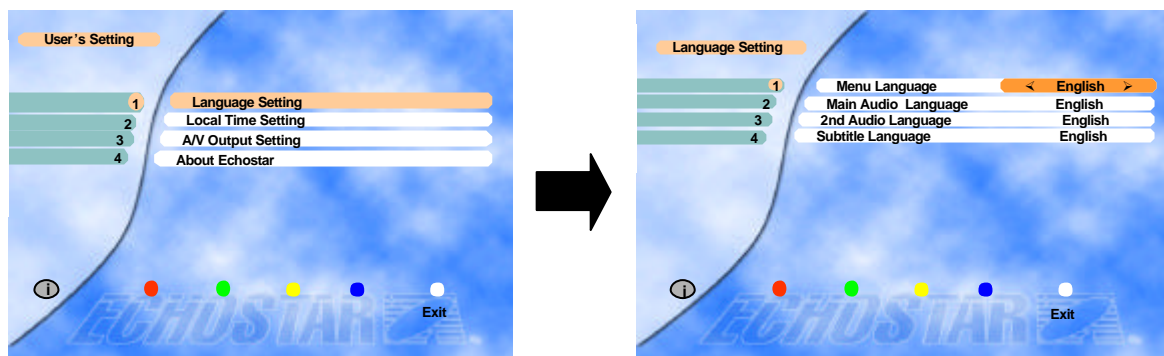

You can select the desired language for the OSG (On-Screen Graphics) display using the , . keys when the “Menu Language” option is selected. Similarly you can select a different audio channel when the “Audio Language” option is selected. This option allows you to select a different language to listen to if supported.

Subtitle

Select the “Subtitle Language” in the “*Language Setting*” menu. While viewing a channel, the subtitling option is available only when the selected subtitling language is provided by the broadcaster.

To check if the subtitling language is available, press “” key on the remote control unit, to show a list with all available subtitling languages.



Local Time Setting

To set your local time, input all the required data for the time and date. This information has to be entered to enable recording of the programs of your choice.

After entering the correct data for year, month, date, day, hour, minute, select option 7 (Press the **OK** key to set the time) and press the **OK** key to save the data.

It is recommended that the time and date set in this menu is the same as of your VCR.

Now that the date and time has been set you could edit the VCR timer settings.

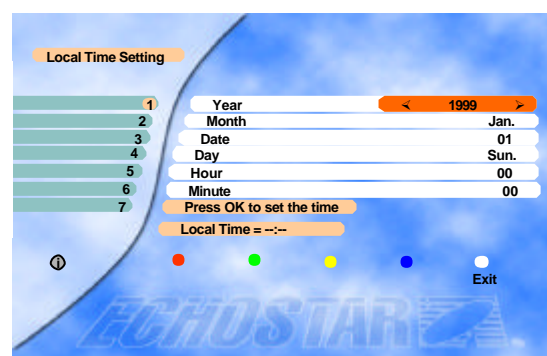

A/V Output Setting

Aspect Please select your TV format.

4:3 for normal screen TV

16:9 for wide screen TV

Banner You can select the time out time(2,3,4,5,8,10 secs) of the banner information about the current channel and program using the ., . keys.

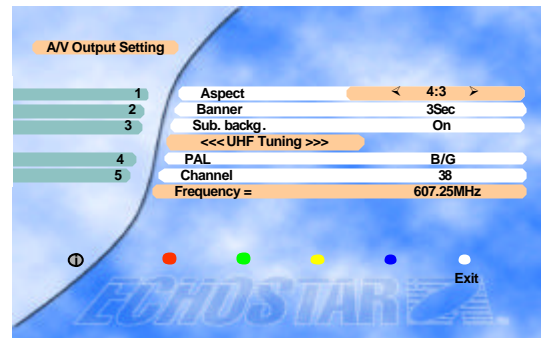

Sub.backg. Select 'On' for Subtitle background on TV (Subtitle background).

UHF Tuning .You can select the type of Video standard by using the ., . keys.

* Video standard : PAL B/G,I , D/K

.Select the vacant channel considering your local channels and preset channels below.

* Pre-set : Ch 38 for PAL B/G,I Ch 40 for PAL D/K

.UHF frequency is set automatically according to the channel selection.

About EchoStar

You can see the details of the company information.

If you have any questions about the **EchoStar AD-3000IP VIACCESS**, firstly contact your local dealer.

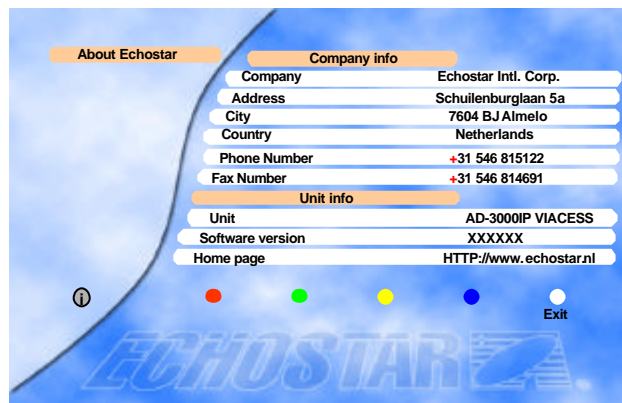

B. Main menu and Installation

Main Menu

Press the **MENU** key to display the “*Main Menu*” on the screen.
 Select a sub-menu using the **., .** keys or the numeric keys. Please note that the **OK** key is always a confirmation of your selection. To go back to the previous menu, press the **MENU** key.

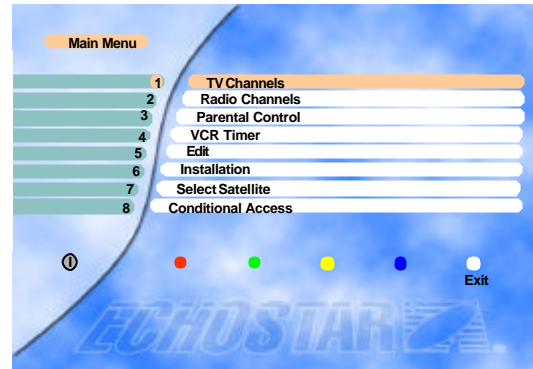

Installation

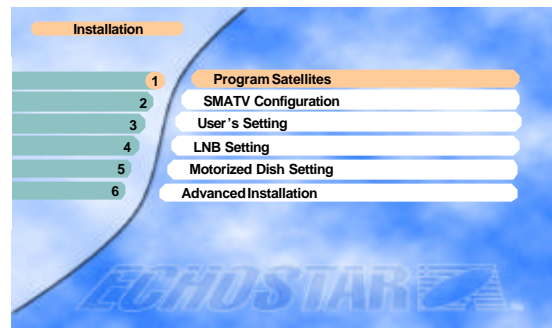
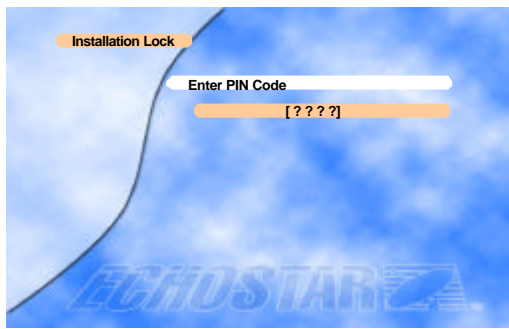

The Installation Lock, “Enter PIN code” menu is displayed only when the Installation and Edit Lock is set as [ON]. The initial code is set as [0000] but you can change it (See “Change PIN code” on page 21).

Program Satellites

Refer to the Signal Quality bar and the Signal Level bar at the bottom of the screen. It is recommended that the signal is at the Medium level or higher. If it is not, please adjust your satellite dish.

This menu is to align your dish to the selected satellite. If you set the “Polarity Control” parameter in the “**LNB Setting**” menu as “Polarotor” or “Ferrite”, you can adjust the “Skew” parameter in this menu while you are watching the signal level at the same time.

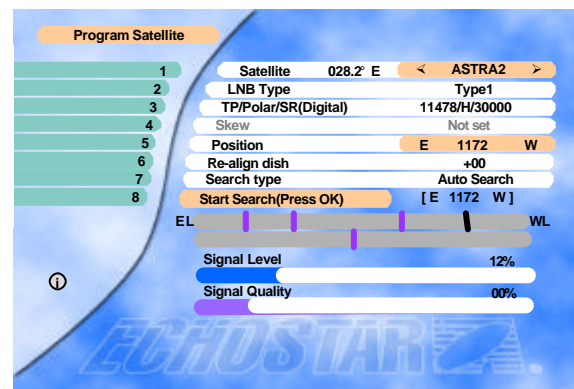

You can move the dish using the **., .** keys when the “Position” option is selected. To locate a satellite move the dish until you have the location of the satellite at which the best signal quality is achieved. Press the **OK** key while still on the “Position” option to store the position. The stored locations for each satellite are shown above the Signal Level bar.

If you are unable to get any signal quality, please check the LNB Setting to ensure you have selected the correct LNB and switch settings.

In some cases it might be necessary to reposition all satellites at once. This can be achieved with the “Re-align dish” option.

Auto Search

Using the Auto Search option, the **EchoStar AD-3000IP VIACCESS** searches for all available channels(Radio and TV) on the currently selected satellite. The names of the found TV channels are shown on the left and the total number of found TV and Radio channels are mentioned on the right.

Note: To stop searching press the  key on the remote control or on the front panel. This cancels the searches and the found channels will be discarded. All other keys of the remote are disabled during searching.

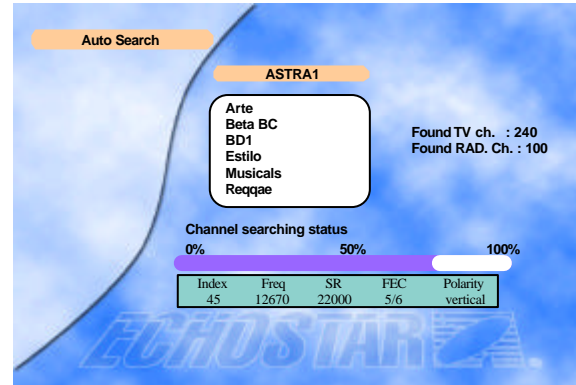

SMATV Configuration

A Satellite Master Antenna Television (SMATV) system which is intended for the distribution of television and sound signals to household in one or 6 more adjacent buildings.

A SMATV System represents a means for sharing the same resources among several users for satellite and terrestrial reception, and it is designed to perform the adaptation of the satellite TV signals to the SMATV channel characteristics.

EchoStar AD-3000IP VIACCESS VIACCESS has a SMATV-IF facility to operate with SMATV. This configuration allows the direct distribution of the QPSK signal received from the satellite to the SMATV-IF distribution network in the extended IF band (above 950 MHz).

Before you start, you have to check your condition whether it is possible to use this facility or not in your households. (You can ask your household supervisor.)

If EchoStar AD-3000IP VIACCESS VIACCESS is connected to a SMATV network, select “**SMATV Configuration**”.

The most common alternatives for “Symbol rate” and “FEC” are already preprogrammed. (When you need to change the “Symbol rate” for the exceptional frequency, select as you know.)

Move to “Start Auto Search” and just press **OK**.

Then, the “**Auto Search**” procedure will start.

To cancel the processing while the “**Auto Search**” is proceeding, press the **MENU** key.

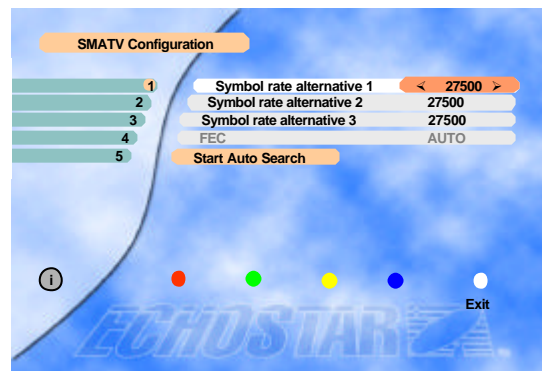

TV Channels

You can select the channel you would like to watch either by pressing the numeric keys for the channel number or by moving the highlighted bar to the channel of your choice using the **.,.** keys. Press the **OK** key to select the channel.

* Press the **.,.** keys to move one page up or down.



Radio Channels

You can select the channel you would like to watch either by pressing the numeric keys for the channel number or by moving the highlighted bar to the channel of your choice using the **.,.** keys. Press the **OK** key to select the channel.

* Press the **.,.** keys to move one page up or down.

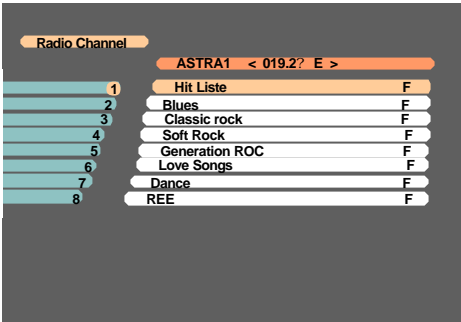

Parental Control

With parental control it can be prevented that a TV channel can be watched, a Radio Channel can be heard, the receiver settings can be changed or an unauthorized change in the installation is performed.

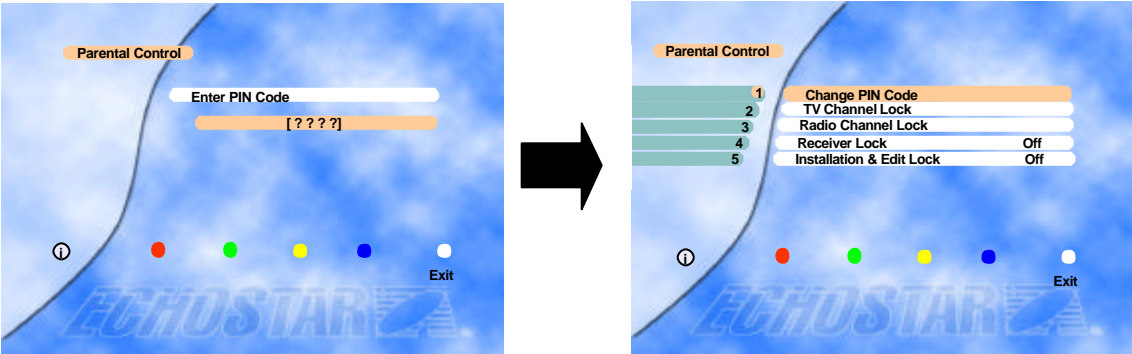

Change PIN Code

The pre-programmed PIN (Personal Identification Number) code is set as [0000]. If you want to change it, please follow the procedure shown as before.

TV Channel Lock

Press the **Red** button to lock / unlock the selected channel.

Locked channels will be skipped when scrolling through the channels.

Press the **VIEW** key to see a thumb nail of the current channel in this menu.

Note) The color of the highlighted bar turns to red when it is on a locked channel.

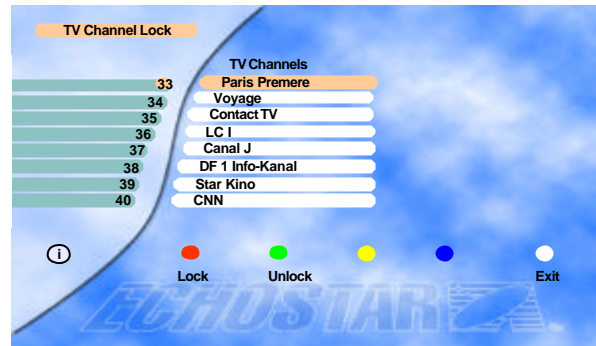

Receiver Lock

If the Receiver Lock is [ON], you have to input the correct code to operate the receiver.

Installation Lock & Edit Lock

If the Installation & Edit Lock is [ON], you have to input the correct code to enter directly into the “*Installation*” and “*Edit*” menu..

VCR Timer Setting

You can edit “*VCR Timer Setting*” only after you input all the data in the “*Local Time Setting*”

Total of 5 events are programmable for your VCR recording with the **EchoStar AD-3000IP VIACCESS**.

Select an event number from 1 to 5, choose your wanted Satellite and Channel (only searched satellites and channels are available to be selected), input Start time and Stop time (not 12-hours & AM/PM, but 24 hour system), select your recording time among O(once) / D(daily) / W(weekly) / M(monthly).

“On” for recording (On/Off) is only available when all the data are properly input or selected.

If recording “On” is not available, you may check the followings ;

- 1) Overlapped Events : Check your prior setting for recording. The time for recording(from Start to Stop) might be overlapped with the new setting.
- 2) Local Time Setting : Any event which starts earlier than your “*Local time Setting*” might not work.

Please turn on your VCR to record an event.

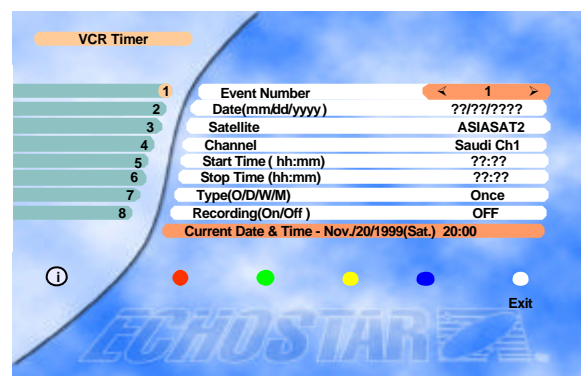

Edit TV Channel

The “Enter PIN code” Menu is displayed only when the Installation and Edit Lock is set as [ON]. The initial code is set as [0000] but you can change it (See “Change PIN code” on page 21).

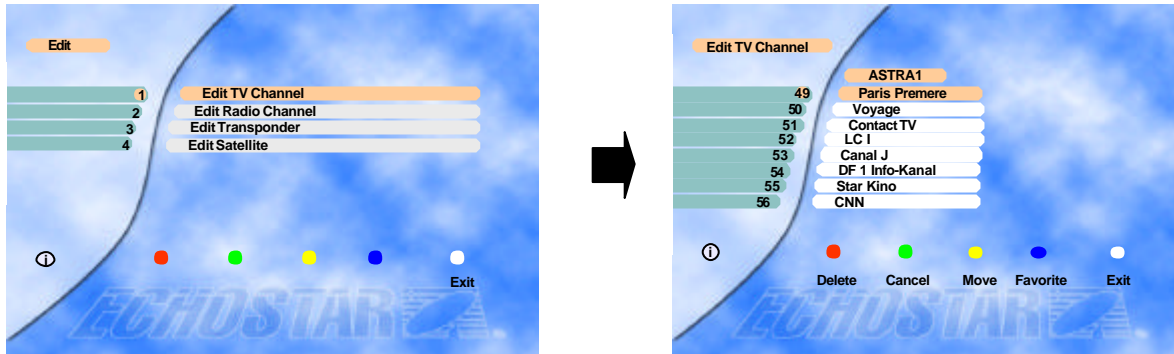

You can move to the channel that you want to edit by using **., .** keys. Also you can move to the highlighted bar directly by inputting the channel number.

FAV Channels

You can create a group of up to 96 channels in the “*Edit TV Channel*” or “*Edit Radio Channel*” menu. To include a channel in the FAV list, select a channel and press the **blue** key on the remote control. To select a favorite channel from the FAV list, press the **FAV** key.

To view a thumb nail representation of the currently selected channel, press the  key on the remote control.

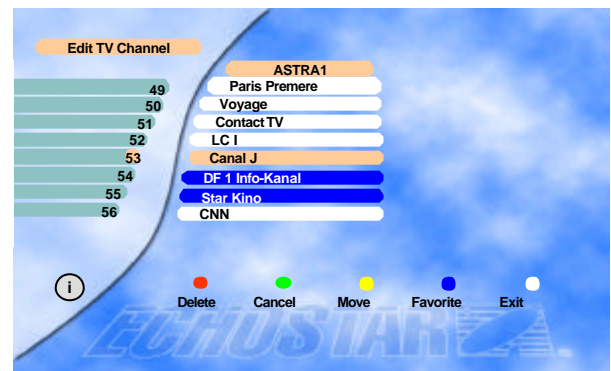

Edit Radio Channel

Use the same procedure for the Radio Channel as used for editing the TV Channels as above.

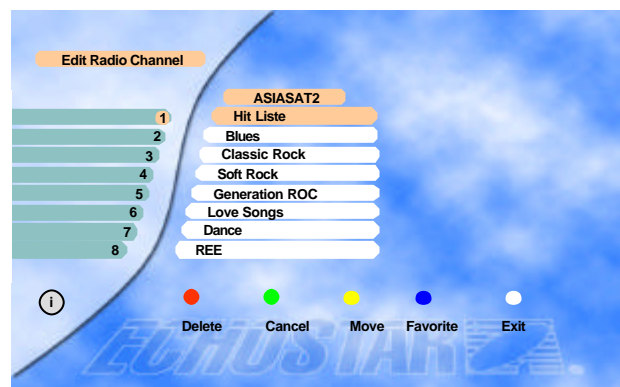

Edit Transponder

To delete a transponder, press the **red** key when the highlighted bar is located at the transponder you want to delete.

To add a transponder, press the **blue** key. And then, the “*Edit/Add SAT or TP*” menu will be displayed, and you can add a transponder in that menu.

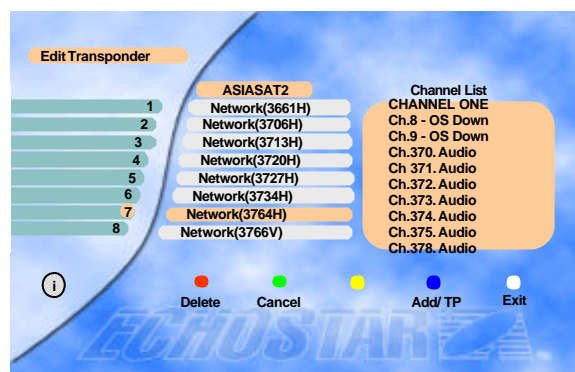

Edit Satellite

To delete a satellite, press the **red** key when the highlighted bar is located at the transponder you want to delete.

To add a satellite, press the **blue** key. And then, “*Edit/Add SAT or TP*” menu will be displayed, and you can add a satellite in that menu.

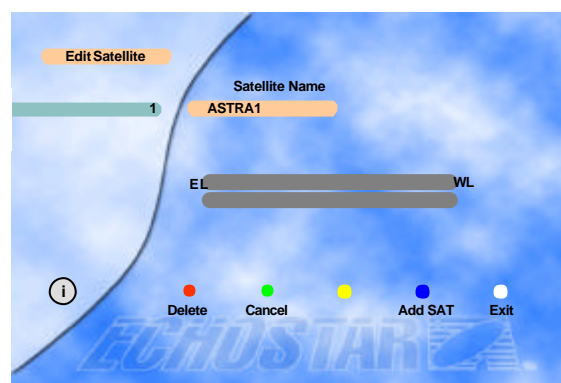

Select Satellite

To move to another satellite you want to watch, press the **SAT** key (⊙) on the remote control and choose the proper satellite with ., . keys.

Press **OK** to confirm.

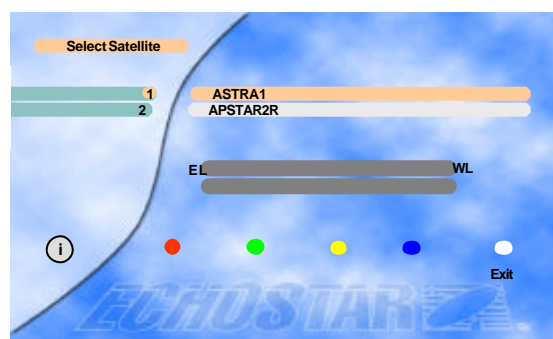

Conditional Access

< Common Interface >

From here you will get access to information and menus from the CI module (Irdeto, Conax, Cryptowork, Nagravision and Viaccess encryption). This information may vary depending on the module.

Please see the documentation delivered together with your CI module.

< Viaccess Embedded >

Insert the Viaccess smart card into the Smart Card slot on the Front Panel. The chip should be faced upwards.

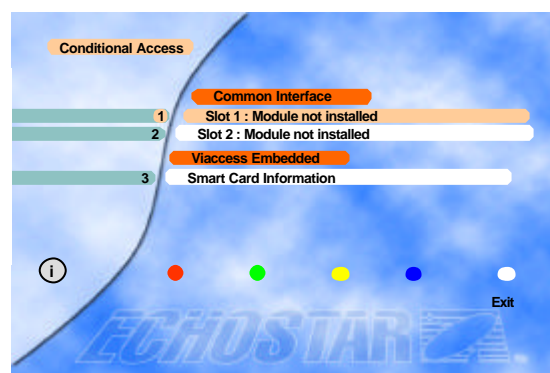

ALT Audio

If more than one audio channel is provided by the broadcaster on a specific channel, you can activate the audio mode display by pressing the  key.



Guide

While watching or listening to any channel and you want to know more information regarding the program shown, press the **EPG** key on the remote control to display the “*TV Guide*” or the “*Radio Guide*”. This information may be provided by the broadcaster. You can move to another channel by pressing the **..** keys or the **..** keys.

Please refer to the function of the keys belows.

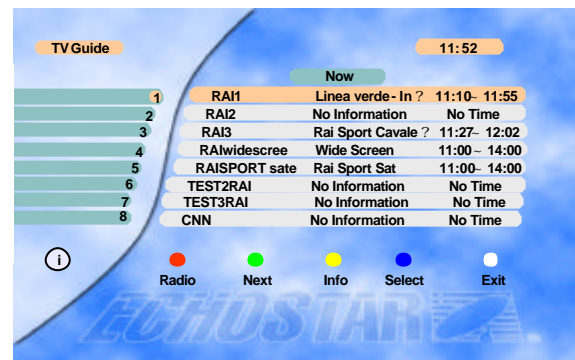

- 1) **Red(TV/Radio)** key : Switches the “*TV Guide*” and the “*Radio Guide*” by pressing this key.
- 2) **Green(Now/Next)** key : Switches the program guides of “Now” and “Next”
- 3) **Yellow(Info)** key : Shows detailed information of the selected channel.
- 4) **Blue(Select)** key : Goes to the viewing mode of the selected channel.
- 5) **White(Exit)** key : Exits the *TV/Radio Guide*

Pressing the **Yellow(Info)** key shows the detailed information of the program and thumbnail of the current channel.



C. Advanced Installation

Advanced Installation

You can select the “*Advanced Installation*” menu on the “*Installation*” menu of Main menu by using the Channel up/down keys (▲,▼).

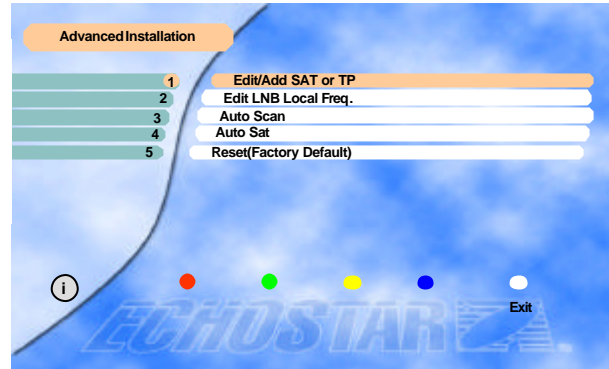

Edit/Add SAT or TP

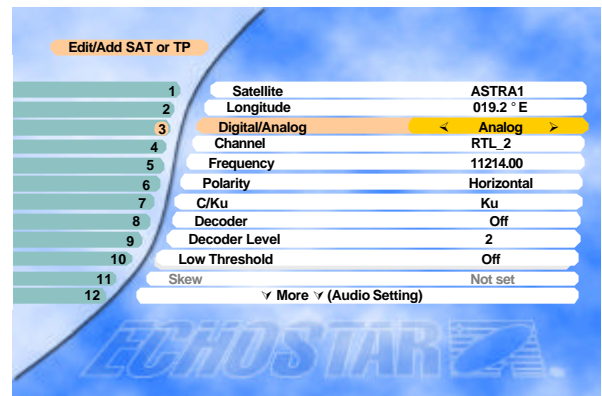
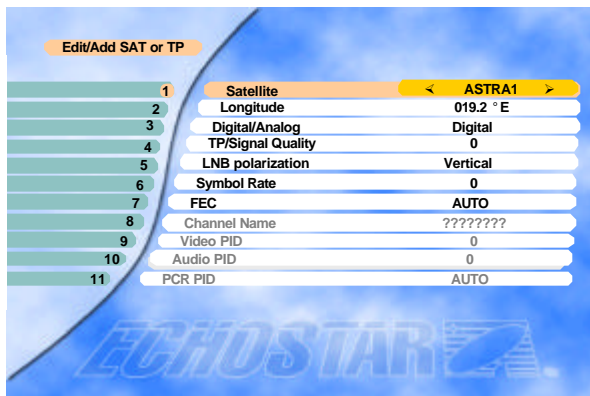

To edit any satellite or transponder, select satellite and transponder to be edited. You can convert from digital to analog and vice versa, at “Digital/Analog” parameter. You can change the name of the satellite, transponder, channel name and such. To change channel name, place highlight bar to “8 Channel Name” and keep pressing one of either the . or . keys till it reaches “??? Add ch”. Then, press the **OK** key to activate graphic key board and now you can edit the name up to 10-character length. For some words,, maximum number of the characters is 11. And, mostly 8 characters from the start shall be shown on the menu when you finish changing name.

Note 1) You should execute “*Auto Search*” after editing the satellite or the transponder. If “*Auto Search*” is executed after adding the new transponder, all channels of the added transponder will be searched and stored automatically.

CAUTION: By doing an Auto Channel search you will lose all the data (e.g. FAV, Lock...) which you have edited.

Note 2) You can add or edit totally of **50 satellites**. This includes the pre-programmed satellites. The receiver has the cap ability to store up to **999 transponders** and **5000 channels**.

Edit LNB Local Frequency

You can edit up to 8 local frequencies by using numeric keys.
And if you want to save the newly edited frequency, press the **OK** key.

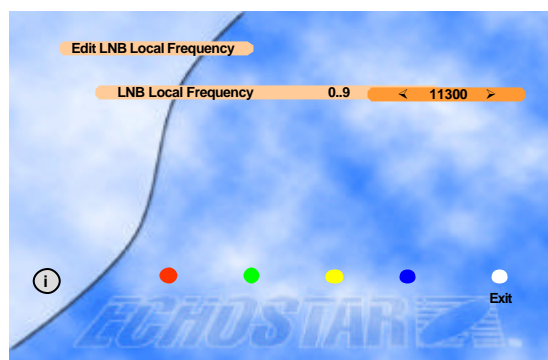

Auto Scan

You can scan analog channels of the chosen satellite automatically in this menu.

Press the **OK** key at the "Start" bar to start channel scanning.
By doing a channel scan you will lose the channel names.
This can be redone by going back to factory default.

This function assists end-users to speed up the searching/storing process. It may be required to fine-tune the video by adjusting the frequency manually.

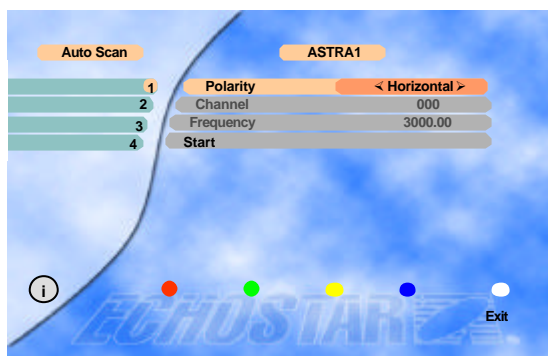

Reset (Factory Default)

If you want to reset all the data edited, press the **Red** button twice.

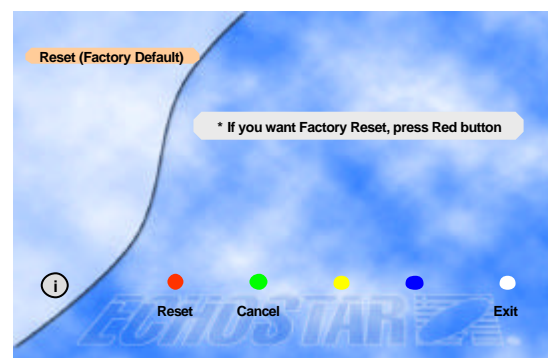

6. Specifications

Digital Section

1. Tuner & channel

Input connector	1 x F type with loop through
Output connector	1 x F type 75 Ohm
Frequency range	950MHz to 2150MHz
Input impedance	75 Ohm
Signal level	-25 to -65dBm
IF frequency	480MHz
IF bandwidth	36MHz
LNB power & polarization	Vertical +13.5V - +14.5V Horizontal +17.5V - +18.5V
22kHz tone	Frequency 22kHz \pm 2kHz Amplitude 0.6Vp-p \pm 0.2Vp-p
Demodulation	QPSK
Input symbol rate	2 - 32Msps
FEC decoder	Convolutional code rate 1/2, 2/3, 3/4, 5/6 and 7/8 with constraint Length K=7

2. MPEG transport stream A/V decoding

Transport stream	MPEG-2 ISO/IEC 13818 Transport stream specification
Profile & level	MPEG-2 MP @ ML
Input T/S data rate	90Mbit/S max.
Aspect ratio	4:3, 16:9 with pan vector
Video resolution	720 x 576(PAL), 720 x 480(NTSC)
Audio decoding	MPEG-1 Audio Layer 1 & 2, Musicam
Audio mode	Stereo, Dual channel, Joint stereo, Mono
Sampling rate	32, 44.1 and 48kHz

3. Memory

Flash memory	up to 2 Mbytes
Program DRAM	up to 8 Mbytes
EEPROM	2 Kbytes

4. A/V & data in/out

SCART	TV x 1, VCR x 1, Decoder x 1
RGB video output	TV SCART
0/12V out	RCA x 1
CVBS video out	RCA x 1, SCART x 2 (TV, VCR)

S/PDIF out	RCA x 1
Analog audio out	RCA x 2 (L-Ch x 1, R-Ch x 1), SCART x 2 (TV, VCR) Resolution 16bit DAC Output level 2Vrms max. Volume & mute control
Data interface	RS232C, Baud Rate 9600 - 115200, 9 Pin D-Sub
5. PCMCIA	
Number of Slot	2
Type	I, II DVB Common interface standard
6. Conditional Access	
Embedded Viaccess	1 Smart Card Reader
7. RF-Modulator	
RF-connect	75 Ohm, IEC169-2, male/female
Output Frequency	470MHz to 860MHz
Output channel	Ch21 - 69
TV standard	PAL D/K, PAL B/G , PAL I
8. Power supply	
Input voltage	AC90 - 240V, 50/60Hz (Receiver / Positioner)
Type	Linear PWM
Power consumption	240W max.(below 7W max. for standby mode)
Protection	Separate internal fuse and chassis grounding. The input shall have lightning or electric shock protection.
9. Physical specification	
Size(W x H x D)	370mm x 60mm x 280mm
Weight	about 3 Kg
10. Environment	
Operating temperature	+5°C - +40°C
Storage temperature	-40°C - +65°C
11. Positioner	
Satellite position	50
Azimuth & Skew control	6 Push terminal (M1, M2, M.Pulse, +5V, GND, Skew)
Output power	36VDC, 5A max. (during 5 minutes) (SMPS)
Sensor type	Reed or Hall effect switch
Ferrite control	2 Push terminal(+,-)

Analog Section

1. RF

Input frequency range	900MHz to 2150MHz
Input impedance	75 Ohms
IF bandwidth	27MHz
IF frequency	479.5MHz
Input signal level	-60 to -30dBm
Threshold	6dB Typ. (3dB: low threshold mode, 32 Steps)

2. Audio

Subcarrier tuning range	5.0 to 9.0MHz
De-emphasis	J-17 / 50uS / 75uS / Adaptive (Panda-compatible)
IF bandwidth	130kHz / 150kHz / 230kHz / 280kHz / 330kHz / 500kHz
Audio frequency response	20Hz to 15kHz
Output impedance	600 Ohms
Output level	2.0 Vrms Max.

3. Video

Format	Invert / Normal (C/ Ku) Selectable video output
De-emphasis	CCIR Recommendation 405-1, 625 lines
Output impedance	75 Ohms
Frequency response	50Hz to 5.0MHz
Output level	1 Vp-p normal

4. Decoder format

Format	Base band De-Emphasized, Unclamped, Un-Filtered, De-Emphasized, Unclamped, Filtered, De-Emphasized, Clamped, Filtered
Output impedance	75 Ohms
Output level	1 Vp-p nominal